

	1
1.1	1
1.2	1
	
2.1	3
2.2	4
2.3	4
2.4	5
2.5	7
2.5.1	7
2.5.2	7
2.5.3	9
2.5.4	9
2.6	10
2.6.1	10
2.6.2	10
2.7	11
2.8 I/O	12
2.9	14
	1
3.1	15
3.1.1	15
3.1.2	16
	1
	2
5.1	24
5.2	25
5.3	26
5.4	27
5.5	28

1.1

1 ()

1

2

3

2 ()

1 I/O

3 ()

1

4

1 37

2

1.2

1

2

3

4

5

6

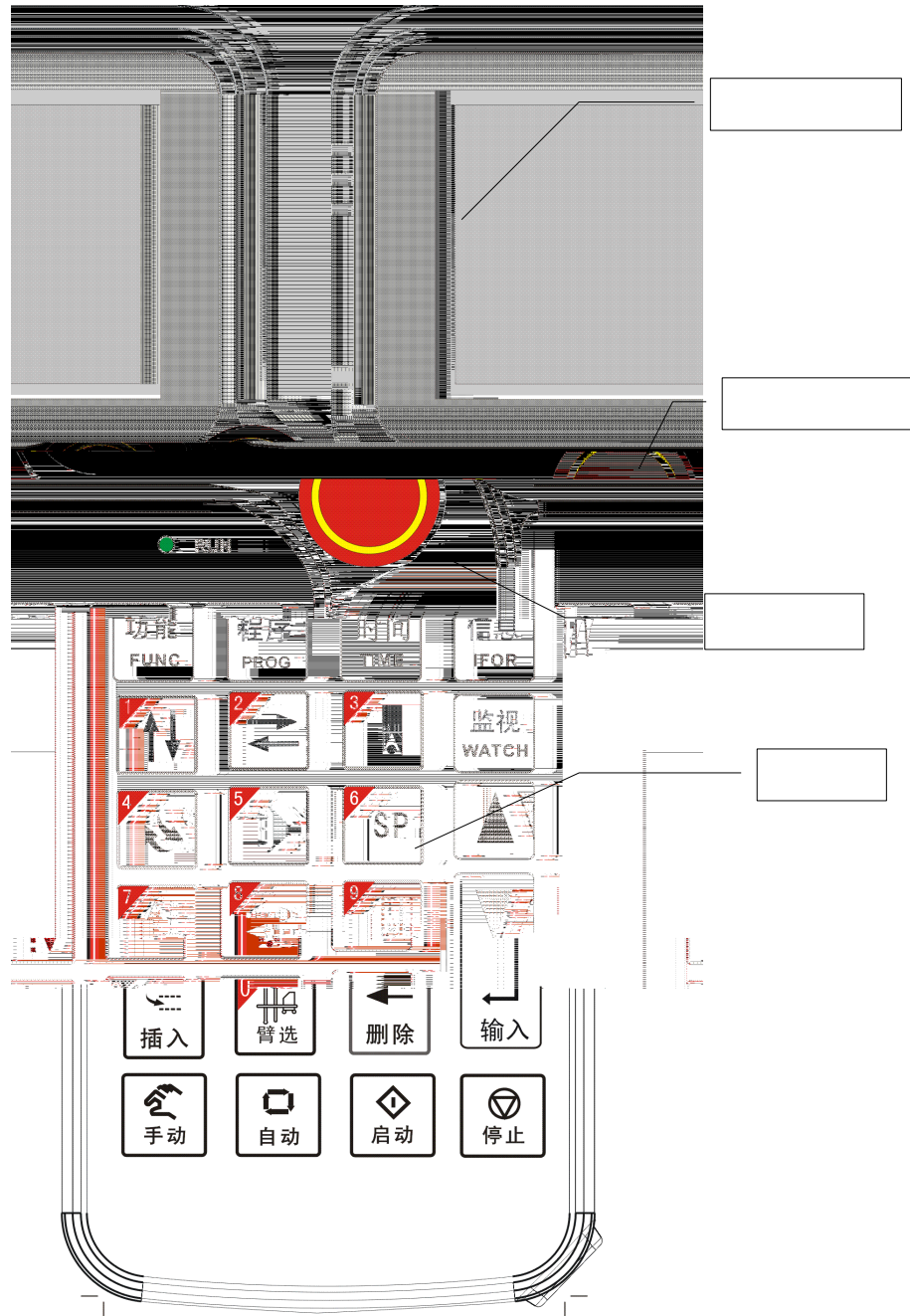

2 2

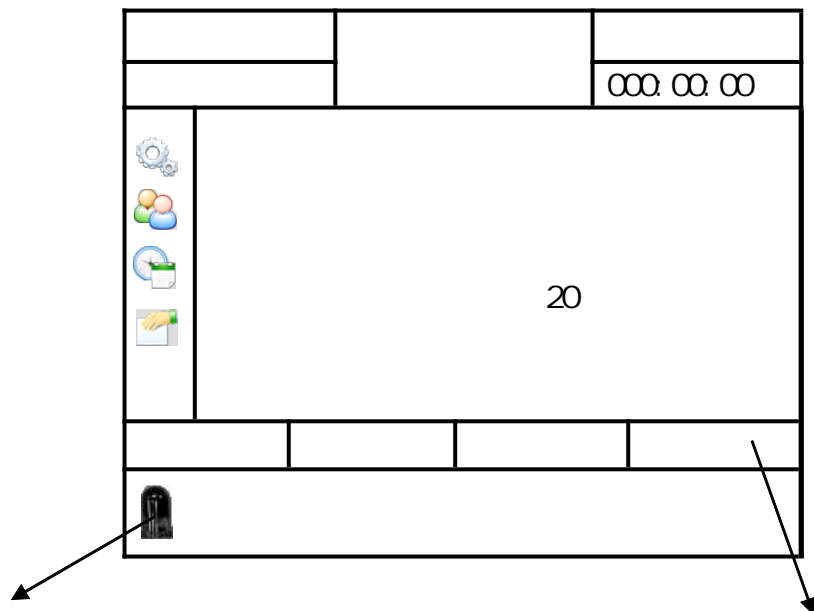

2 3

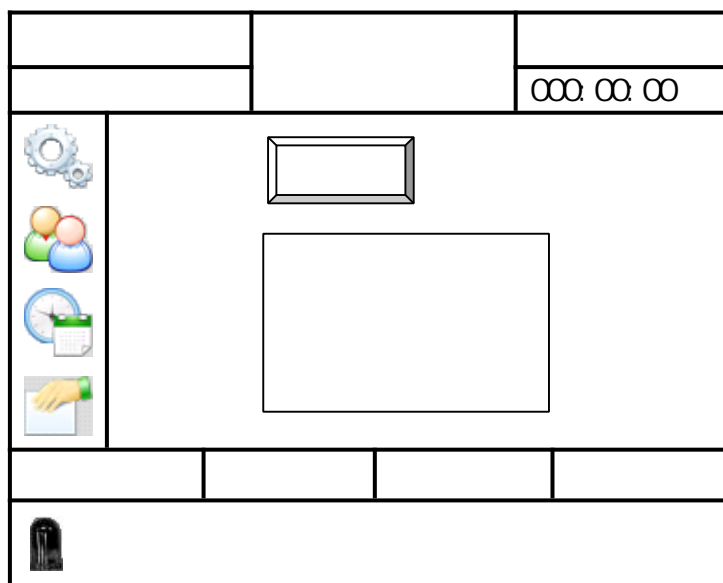



/

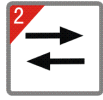

/



/



/



/



/



/



/



/



2 4



2 5

2 5.1

功能
FUNC

/

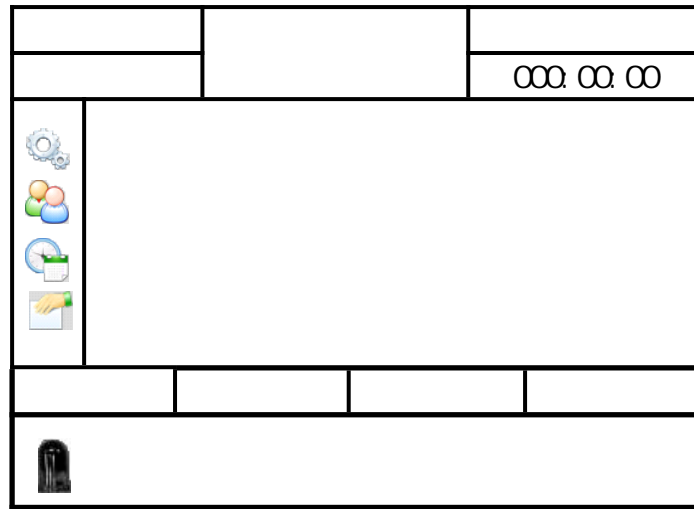

1
2

3

ON

OFF





4
5

ON

2 5.2

功能
FUNC

:

			000.00.00
   	***		
			

2011



/

		1	000.00.00
	00001 0600.0 S 0600.0 S		0200 S 32767
			

1

2

" "

" "

3

4

:

" 3"

3

5

6

7

8

9

10

15

15





15

11

2.5.3

2012,



		2	
			000 00 00
   	HC19001 2011-05-06 1.0.0.1		
			

1

2

2.5.4



:

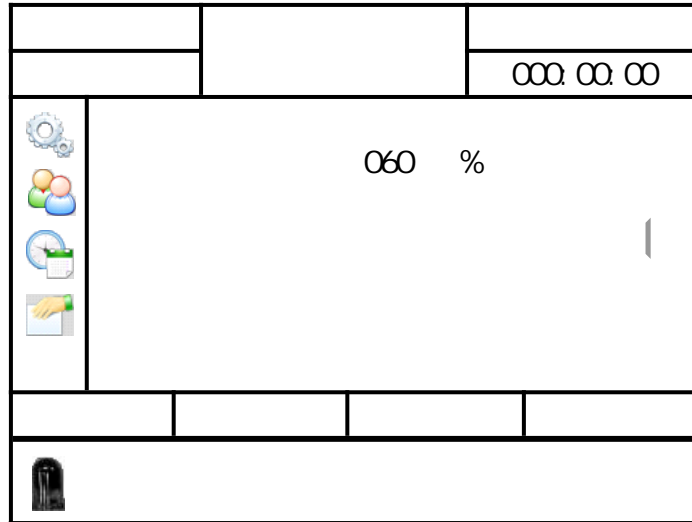

2 6

2 6.1

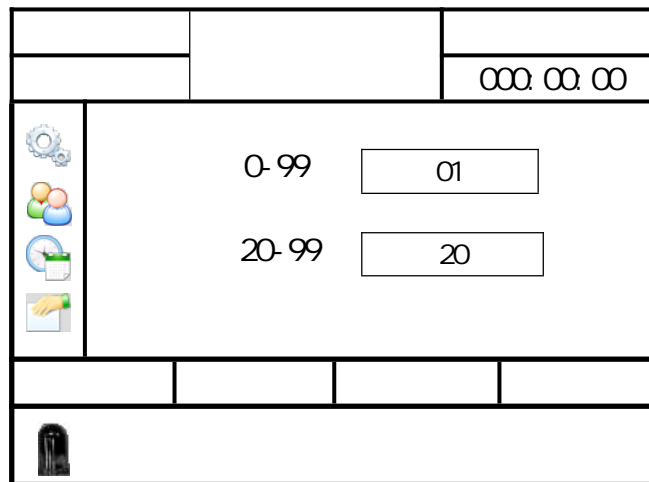

“ ”

2 6.2

20 100 20 0-19
 20-99

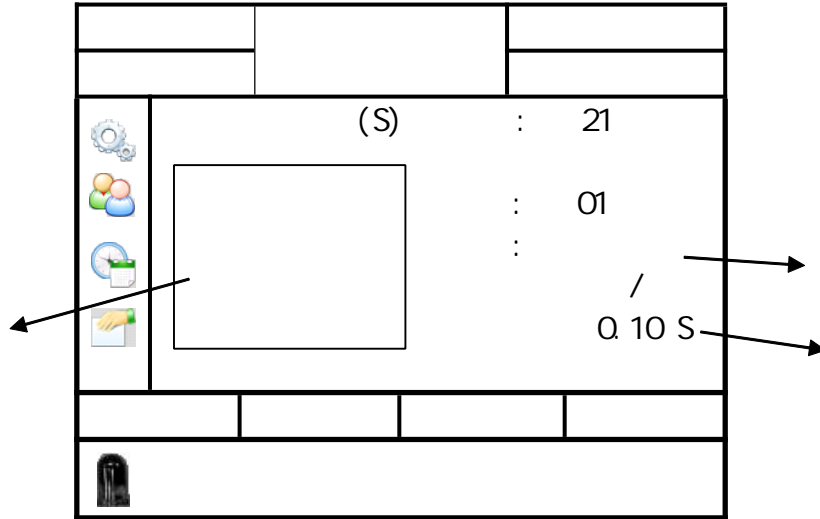

时间
TIME

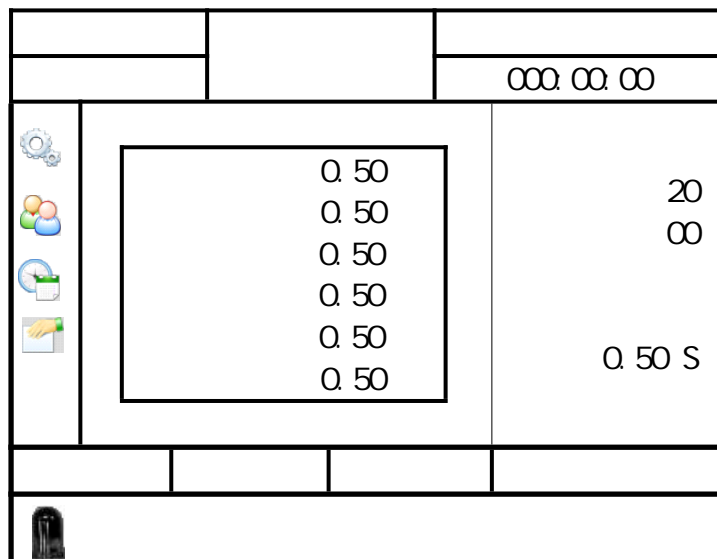

2 8 1 / 0

000. 00. 00

LS1
LS2
LS3
LS4
LS5
LS6
LS7

LS8
LS9
LS10

,

:

LS
1
2
3
4
5
6
7
8
9
10
11
12
13

SQL
1
2
3
4
5
6
7
8
9
10
11
12
13
14
15
16

信息
IFOR

			000. 00. 00
01	[35]	off	
02	[33]	On,	
03	[31]	On,	
04	[59]		
05	[73]		
06	[06]	On.	Off
			

48



1-48

信息
IFOR

			000. 00. 00
		(S)	
01	20	025. 40	
02	20	026. 30	
03	20	024. 50	
04	20	023. 38	
05	20	022. 40	
06	20	021. 40	
			

3.1

3.1.1

0
0000 ⇨ 0001 ⇨ 0002 ⇨ 0003
⇨ 0004 ⇨ 0005 ⇨ 0006 ⇨ 0007
⇨ 0008 ⇨ 0009 ⇨ 0010 ⇨ 0011
⇨ 0012

1
0100 ⇨ 0101 ⇨ 0102 ⇨ 0103
⇨ 0104 ⇨ 0105 ⇨ 0106 ⇨ 0107
⇨ 0108 ⇨ 0109 ⇨ 0110 ⇨ 0111
⇨ 0112 ⇨ 0113

2
0200 ⇨ 0201 ⇨ 0202 ⇨ 0203
⇨ 0204 ⇨ 0205 ⇨ 0206 ⇨ 0207
⇨ 0208 ⇨ 0209 ⇨ 0210 ⇨ 0211
⇨ 0212

3
0300 ⇨ 0301 ⇨ 0302 ⇨ 0303
⇨ 0304 ⇨ 0305 ⇨ 0306 ⇨ 0307
⇨ 0308 ⇨ 0309 ⇨ 0310 ⇨ 0311
⇨ 0312 ⇨ 0313

4
0400 ⇨ 0401 ⇨ 0402 ⇨ 0403
⇨ 0404 ⇨ 0405 ⇨ 0406 ⇨ 0407
⇨ 0408 ⇨ 0409 ⇨ 0410 ⇨ 0411
⇨ 0412

5
0500 ⇨ 0501 ⇨ 0502 ⇨ 0503
⇨ 0504 ⇨ 0505 ⇨ 0506 ⇨ 0507
⇨ 0508 ⇨ 0509 ⇨ 0510 ⇨ 0511
⇨ 0512 ⇨ 0513 ⇨ 0514 ⇨ 0515
⇨ 0516

6

0600	⇒ 0601	⇒ 0602	⇒ 0603
⇒ 0604	⇒ 0605	⇒ 0606	⇒ 0607
⇒ 0608			

7			
0700	⇒ 0701	⇒ 0702	⇒ 0703
⇒ 0704	⇒ 0705	⇒ 0706	⇒ 0707
⇒ 0708	⇒ 0709		

3.1.2

0			
0000	⇒ 0001	⇒ 0002	⇒ 0003
⇒ 0004	⇒ 0005	⇒ 0006	⇒ 0007
⇒ 0008	⇒ 0009	⇒ 0010	⇒ 0011
⇒ 0012	⇒ 0013	⇒ 0014	⇒ 0015
⇒ 0016	⇒ 0017	⇒ 0018	

1			
0100	⇒ 0101	⇒ 0102	⇒ 0103
⇒ 0104	⇒ 0105	⇒ 0106	⇒ 0107
⇒ 0108	⇒ 0109	⇒ 0110	⇒ 0111
⇒ 0112	⇒ 0113	⇒ 0114	⇒ 0115
⇒ 0116	⇒ 0117		

2			
0200	⇒ 0201	⇒ 0202	⇒ 0203
⇒ 0204	⇒ 0205	⇒ 0206	⇒ 0207
⇒ 0208	⇒ 0209	⇒ 0210	⇒ 0211
⇒ 0212			

3			
0300	⇒ 0301	⇒ 0302	⇒ 0303
⇒ 0304	⇒ 0305	⇒ 0306	⇒ 0307
⇒ 0308	⇒ 0309	⇒ 0310	⇒ 0311
⇒ 0312	⇒ 0313		

4			
0400	⇒ 0401	⇒ 0402	⇒ 0403
⇒ 0404	⇒ 0405	⇒ 0406	⇒ 0407
⇒ 0408	⇒ 0409	⇒ 0410	⇒ 0411

0412

5

0500

0501

0502

0503

0504

0505

0506

0507

0508

0509

0510

0511

0512

0513

6

0600

0601

0602

0603

0604

0605

0606

0607

0608

0609

0610

0611

0612

7

0700

0701

0702

0703

0704

0705

0706

0707

0758

0709

0710

0711

0712

0713

0714

0715

0716

8

0800

0801

0802

0803

0804

12
1200 ⇨ 1201 ⇨ 1202 ⇨ 1203
⇨ 1204 ⇨ 1205 ⇨ 1206 ⇨ 1207
⇨ 1208 ⇨ 1209 ⇨ 1210 ⇨ 1211
⇨ 1212 ⇨ 1213

13
1300 ⇨ 1301 ⇨ 1302 ⇨ 1303
⇨ 1304 ⇨ 1305 ⇨ 1306 ⇨ 1307
⇨ 1308 ⇨ 1309 ⇨ 1310 ⇨ 1311
⇨ 1312

14
1400 ⇨ 1401 ⇨ 1402 ⇨ 1403
⇨ 1404 ⇨ 1405 ⇨ 1406 ⇨ 1407
⇨ 1408 ⇨ 1409

15
1500 ⇨ 1501 ⇨ 1502 ⇨ 1503
⇨ 1504 ⇨ 1505 ⇨ 1506 ⇨ 1507
⇨ 1508

16
1600 ⇨ 1601 ⇨ 1602 ⇨ 1603
⇨ 1604 ⇨ 1605 ⇨ 1606 ⇨ 1607
⇨ 1608 ⇨ 1609 ⇨ 1610 ⇨ 1611
⇨ 1612 ⇨ 1613 ⇨ 1614 ⇨ 1615
⇨ 1616

17
1700 ⇨ 1701 ⇨ 1702 ⇨ 1703
⇨ 1704 ⇨ 1705 ⇨ 1706 ⇨ 1707
⇨ 1708 ⇨ 1709 1710 1711
1712 1713 1714

" STOP "

05 06	01 ON ON !	1. 2 I/O 3
01	02 ON !	1. 2 3 I/O 4.
01	03 OFF !	1. 2 3 I/O 4.
07 04	04 ON OFF !	1. 2 3 I/O 4.
04 02	05 ON OFF !	1. 2 3 I/O 4.
11 03	06 ON OFF !	1. 2 3 I/O 4.
07 04	07 OFF ON	1. 2 I/O 3
04 02	08 OFF ON	1. 2 I/O 3

11 03	09 OFF ON		1. 2 I/O 3
05 04	10 ON OFF		1. 2 3 4 I/O 5
06 05	11 OFF OFF		1. 2 3 4 I/O 5
04 03	12 ON ON	()	1. 2 3 I/O 4
11 03	13 ON ON !	()	1. 2 3 I/O 4
	31 OFF		1. 2 3 I/O 4
	32 OFF		1. 2 3 I/O 4
	33 ON		1. 2 3 I/O 4
07	34 OFF		1. 2 3 I/O 4

	35 OFF		1. 2 3 I/O 4
01	45 ON	,	1.
09	46 ON	,	1.
01	47 OFF	,	1. 2 3 I/O 4
09 07	50 ON OFF		1. 2 3 I/O 4
06 05	51 OFF OFF	,	1. 2 3 I/O 4
04	52 ON		1. 2 3 I/O 4
11	53 ON		1. 2 3 I/O 4
07	54 ON		1. 2 3 I/O 4

55

1.

09

OFF

2

I/O

72		1.
73 orf		1. 2. 3 I/O 4.

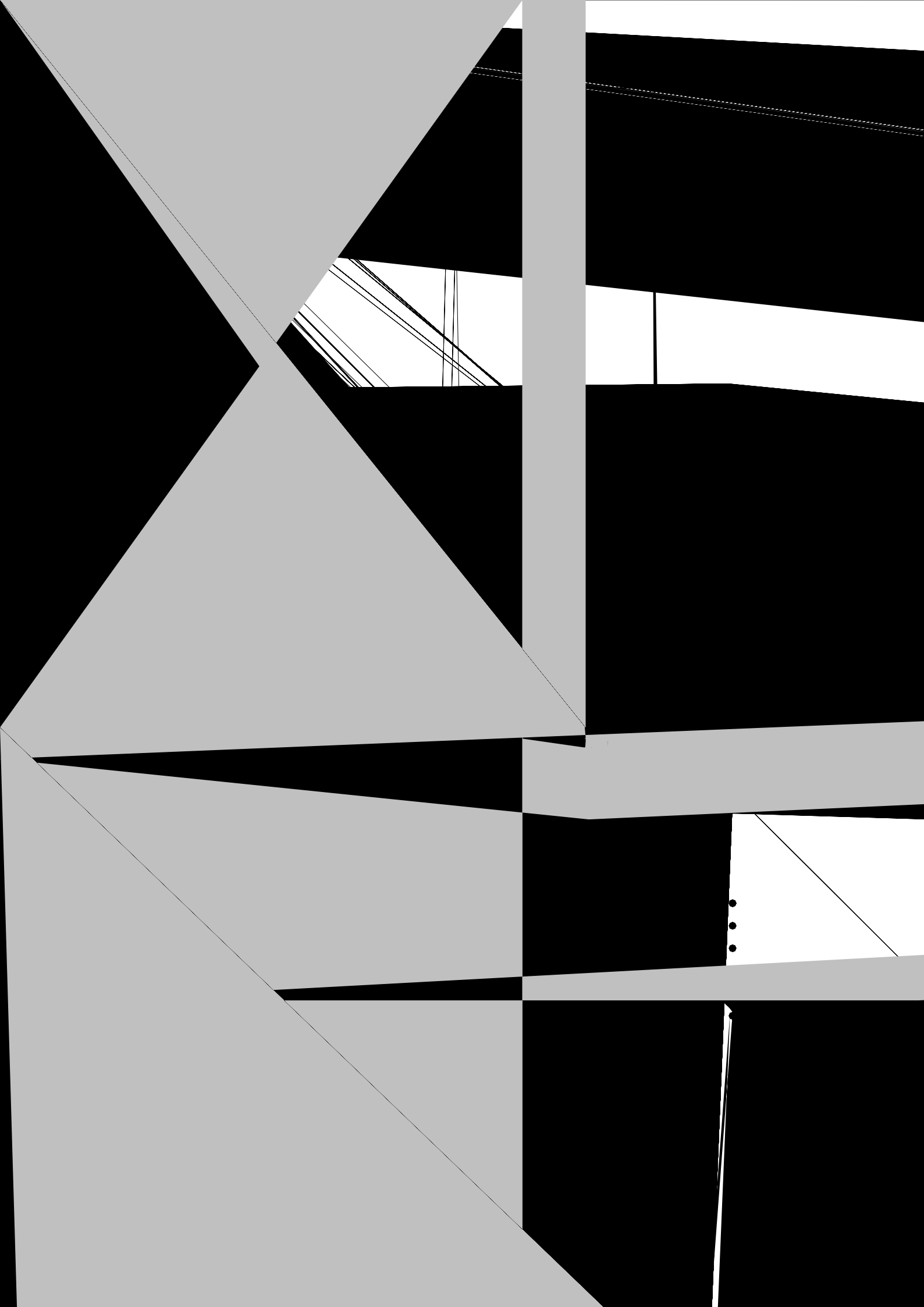

5.2

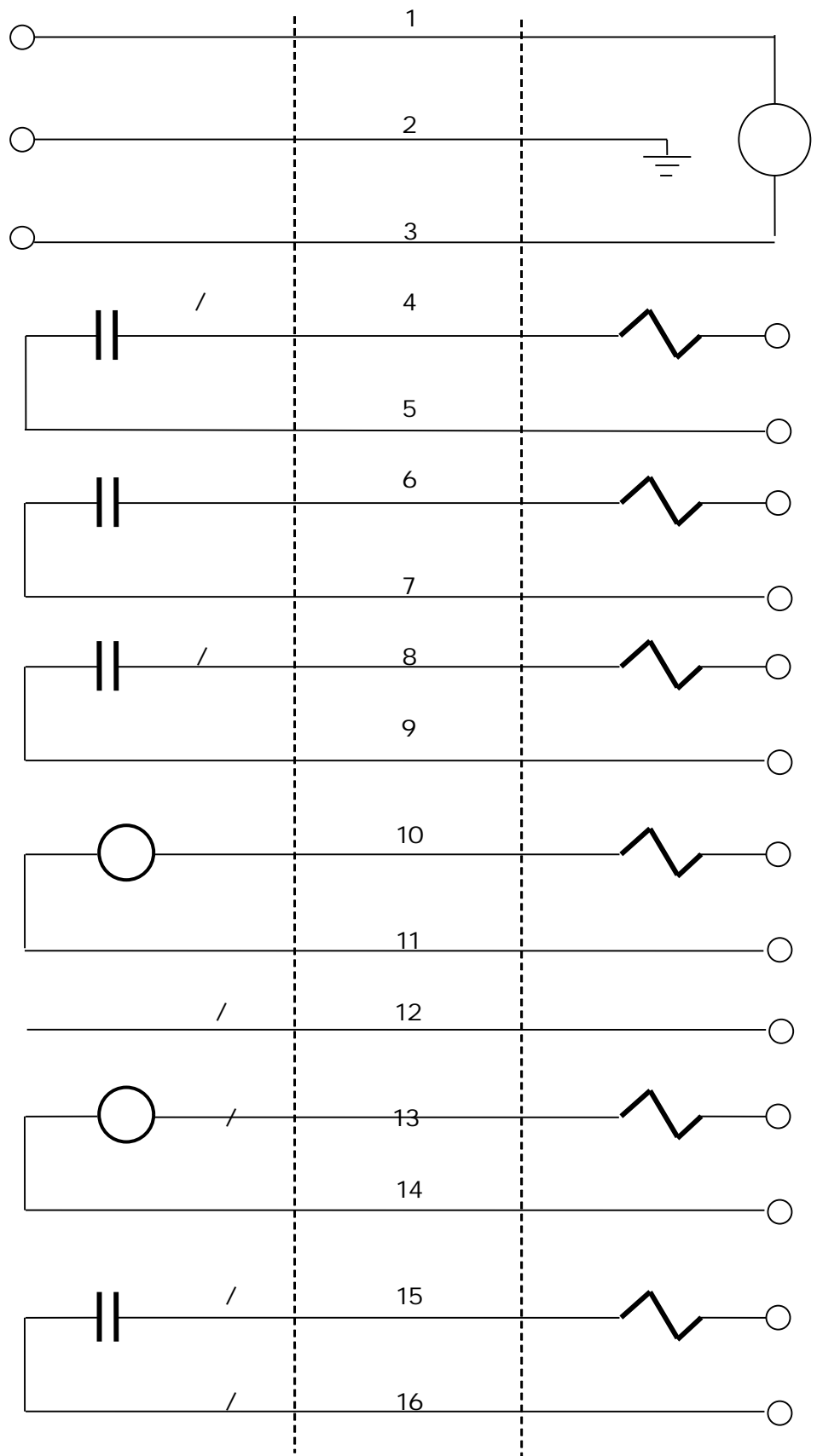

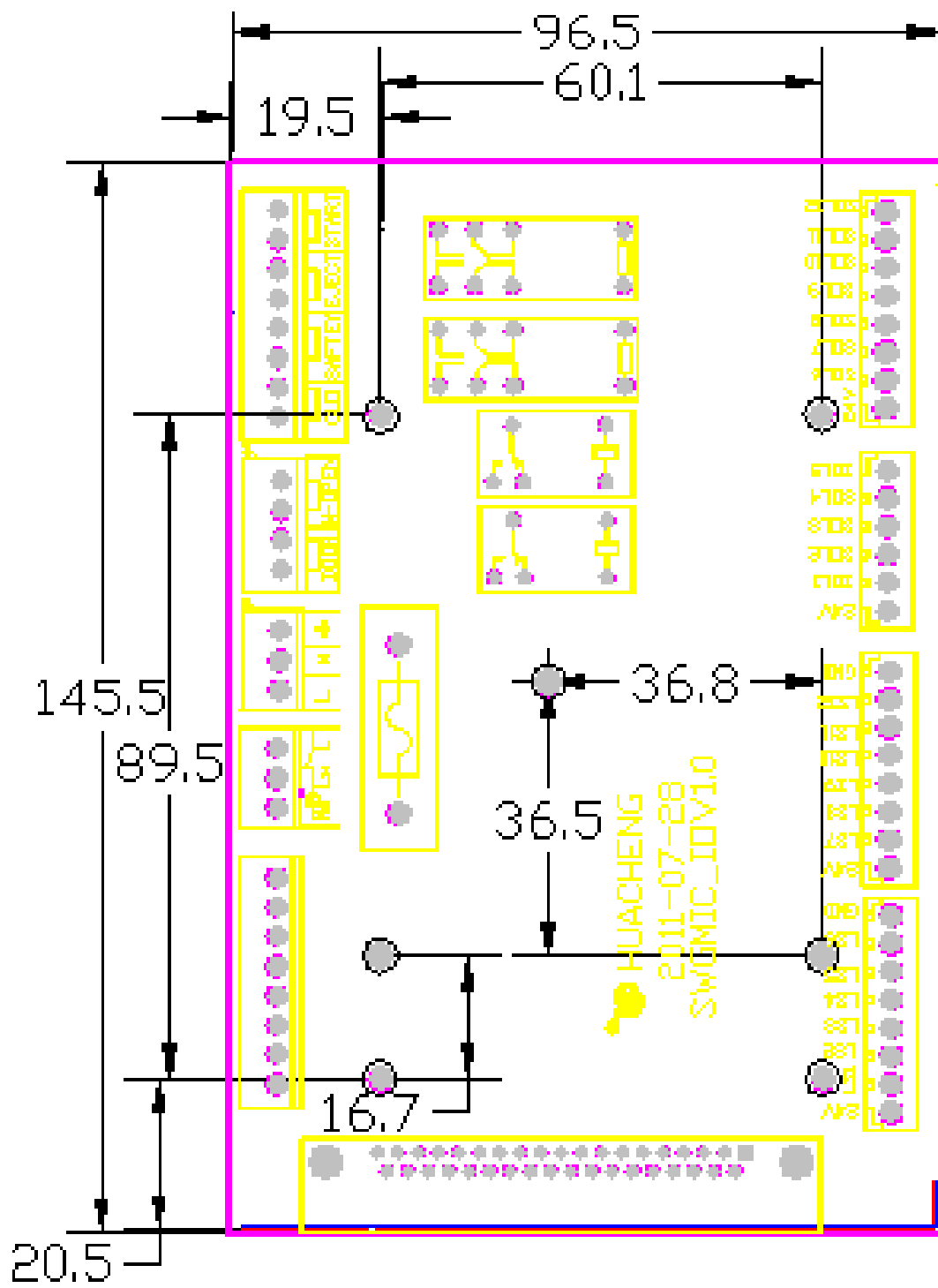

5.4

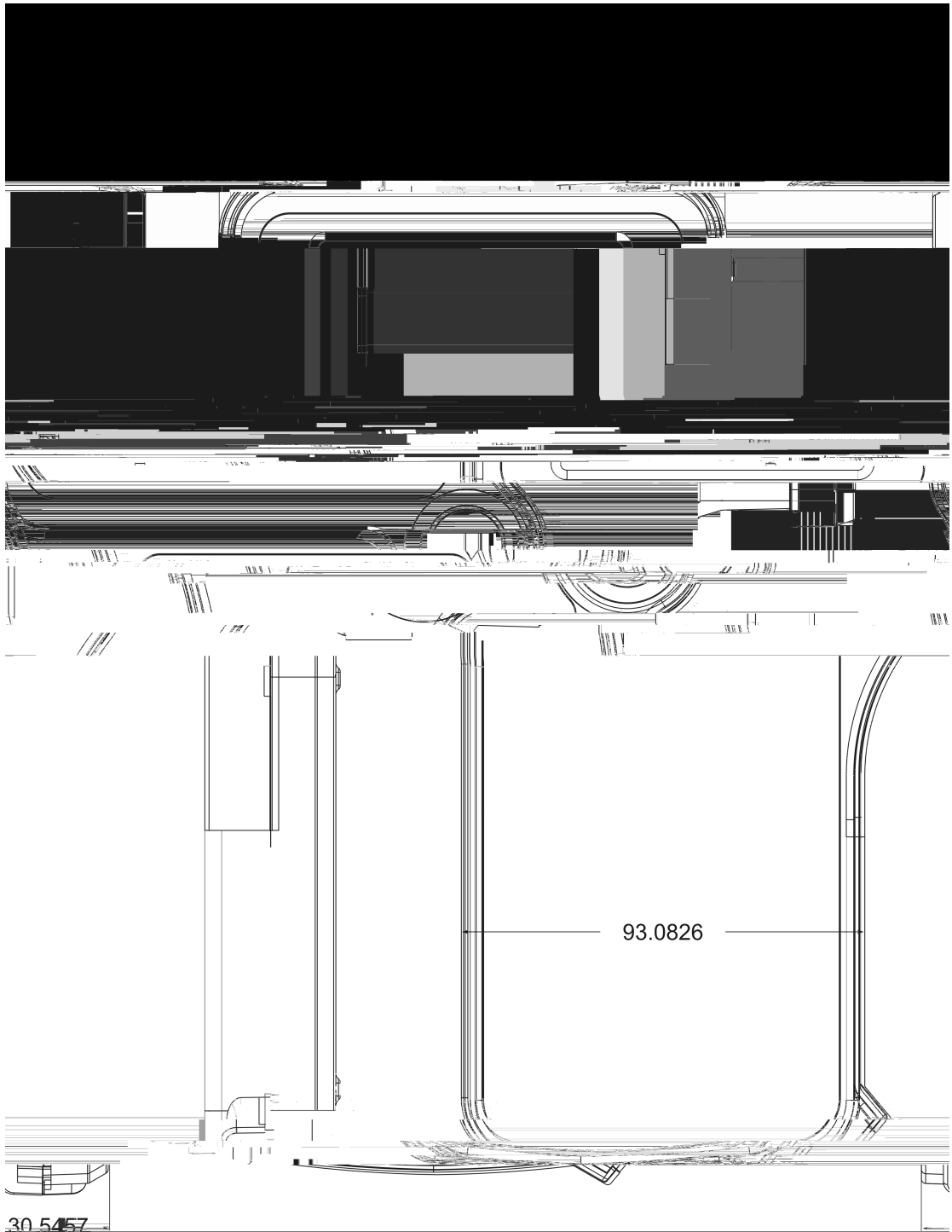

5.5

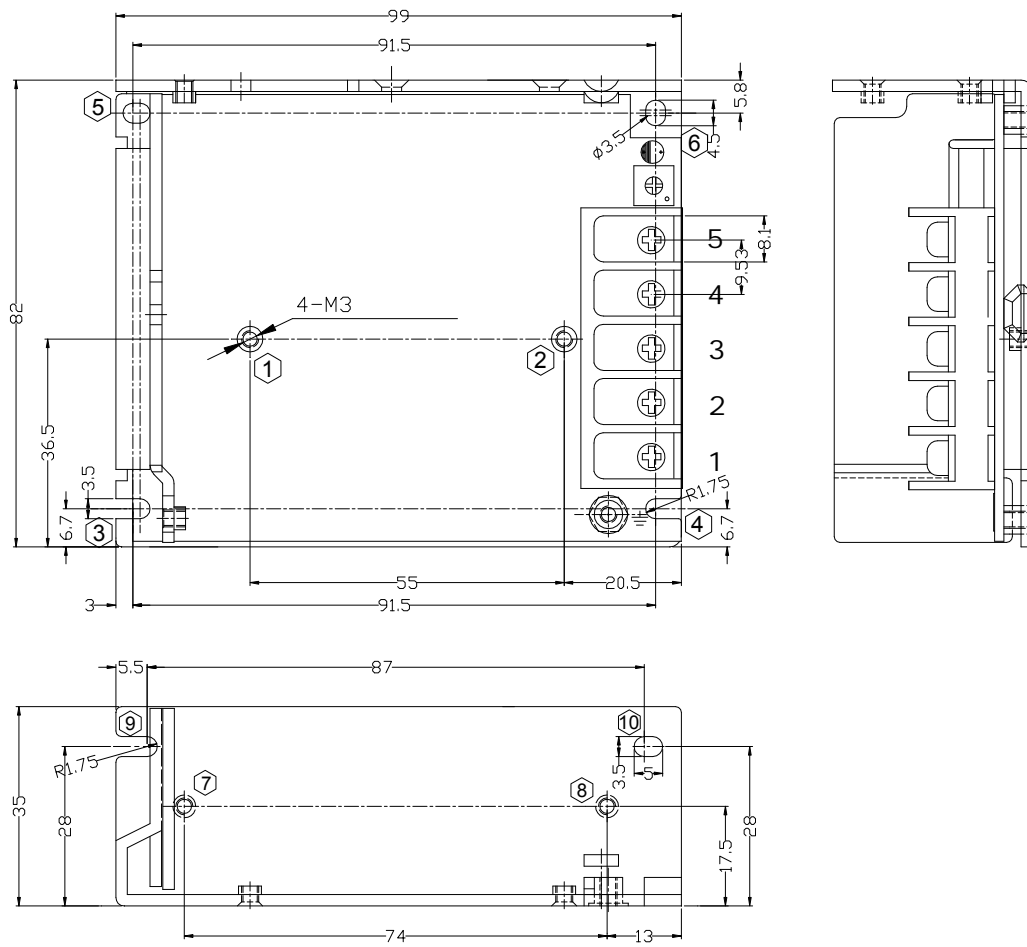

			Lmax	(max)
		①-②	M3	4mm
		③-⑥	M3	4mm
		⑦-⑧	M3	4mm
		⑨-⑩	M3	4mm
				6.5Kgf.cm (max)
				6.5Kgf.cm (max)

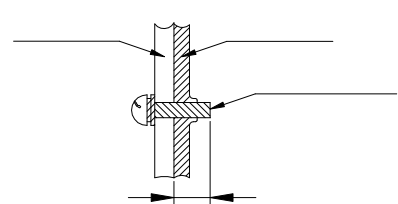

1. L

1,

1	N	9.5	22-14AV6	12Kgf.cm (max)
2	L			
3	⊖			

2,

4	+V	9.5	22-14AV6	12Kgf.cm (max)
5	-V			

,

,